



Commercial status

Discontinued on: 28 June 2019

To be end-of-service on: 30 June 2024

⚠ Restricted Sales for Services

Main

Range of product	Modicon M238 logic controller
Product or component type	Discrete input module
Discrete input number	32
Discrete input voltage	24 V
Discrete input voltage type	DC

Complementary

Range compatibility	Twido Advantys OTB
Input voltage limits	20.4...28.8 V
Discrete input logic	Sink or source
Discrete input current	5 mA
Input impedance	4.4 kOhm
Number of common point	2
Response time	4 ms at state 0 4 ms at state 1
Isolation between channels	None
Isolation between channels and internal logic	500 V for 1 minute
Current consumption	65 mA at 5 V DC at state 1 for all input
Local signalling	2 display blocks
Electrical connection	1 connector HE10
Mounting support	35 mm symmetrical DIN rail
Net weight	0.081 kg

Environment

Depth	81.3 mm
-------	---------

Disclaimer: This documentation is not intended as a substitute for and is not to be used for determining suitability or reliability of these products for specific user applications

Height	90 mm
Width	29.7 mm

Packing Units

Package 1 Weight	0.200 kg
Package 1 Height	70.000 mm
Package 1 width	100.000 mm
Package 1 Length	125.000 mm

Offer Sustainability

Sustainable offer status	Green Premium product
REACH Regulation	REACH Declaration
REACH free of SVHC	Yes
EU RoHS Directive	Pro-active compliance (Product out of EU RoHS legal scope) EU RoHS Declaration
Mercury free	Yes
RoHS exemption information	Yes
China RoHS Regulation	China RoHS declaration
Environmental Disclosure	Product Environmental Profile
Circularity Profile	End of Life Information
WEEE	The product must be disposed on European Union markets following specific waste collection and never end up in rubbish bins
PVC free	Yes
California proposition 65	WARNING: This product can expose you to chemicals including: Lead and lead compounds, which is known to the State of California to cause cancer and birth defects or other reproductive harm. For more information go to www.P65Warnings.ca.gov

Contractual warranty

Warranty	18 months
----------	-----------

Digital Input Module (32-channel, 24 Vdc)

Dimensions

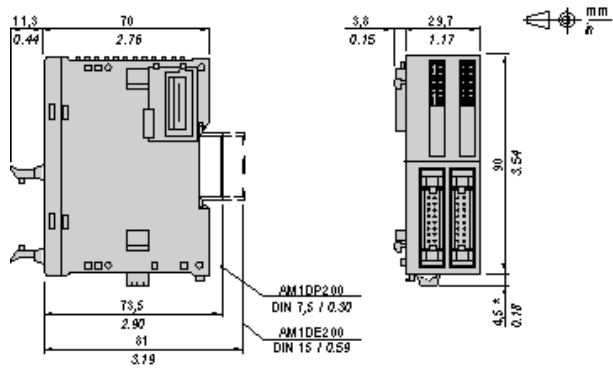

NOTE: * 8.5 mm (0.33 in) when the clamp is pulled out.

DIN Rail Mounting

AM1DE200
IEC/EN 60715

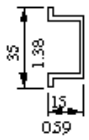

AM1DP200

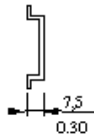

AM1ED200



DZ5MB200



Rail depth	Catalogue part number
15 mm (0.59 in.)	AM1DE200
7,5 mm (0.30 in.)	AM1DP200

NOTE: Do not use AM1ED200 and DZ5MB200





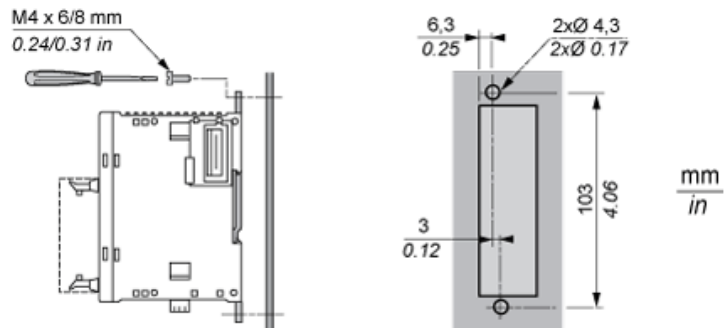

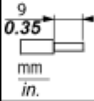

Module Mounting on a Panel Surface

Mounting Hole Layout



Wiring Requirements

Cable Types and Wire Sizes for Removable Screw Terminal Block

							
mm ²	0,14...1,5	0,25...0,5	0,25...1,5	0,14...0,5	0,14...0,75	0,25...0,34	0,5
AWG	26...16	24...20	24...16	26...20	26...18	24...22	20

Digital Input Module (32-channel, 24 Vdc)

Wiring Diagram

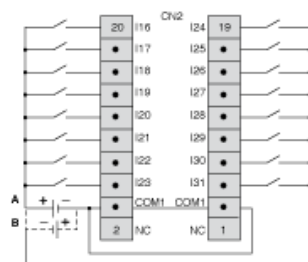
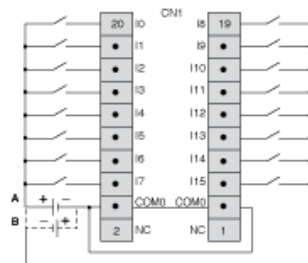

- A Sink wiring (positive logic)
- B Source wiring (negative logic)

TM2DDI32DK is replaced by the following product range:



Modicon TM3

Expansion I/O modules for Modicon M221, M241, M251 and M262

Boost the performance of your controller with the Modicon TM3 I/O system specially designed for the Modicon M221, M241, M251 and M262 logic controllers!