

Product data sheet

Specifications



Inductive proximity sensors XS, inductive sensor XS5 M18, L39mm, brass, Sn5mm, 12...24 VDC, cable 2 m

XS518B1NBL2

Main

Range of product	Telemecanique Inductive proximity sensors XS
Series name	General purpose
Sensor type	Inductive proximity sensor
Device application	-
Sensor name	XS5
Sensor design	Cylindrical M18
Size	39 mm
Body type	Fixed
Detector flush mounting acceptance	Flush mountable
Material	Metal
Type of output signal	Discrete
Wiring technique	3-wire
[Sn] nominal sensing distance	5 mm
Discrete output function	1 NC
Output circuit type	DC
Discrete output type	NPN
Electrical connection	cable
Cable length	2 m
[Us] rated supply voltage	12...24 V DC with reverse polarity protection
Switching capacity in mA	<= 200 mA DC with overload and short-circuit protection
IP degree of protection	IP68 double insulation conforming to IEC 60529 IP69K conforming to DIN 40050

Complementary

Thread type	M18 x 1
Detection face	Frontal
Front material	PPS
Enclosure material	Nickel plated brass
Operating zone	0...4 mm

Differential travel	1...15% of Sr
Cable composition	3 x 0.34 mm ²
Wire insulation material	PvR
Status LED	Output state: 1 LED (yellow)
Supply voltage limits	10...36 V DC
Switching frequency	<= 2000 Hz
Maximum voltage drop	<2 V (closed)
Current consumption	<= 10 mA no-load
Maximum delay first up	10 ms
Maximum delay response	0.15 ms
Maximum delay recovery	0.35 ms
Marking	CE
Threaded length	28 mm
Height	18 mm
Length	39 mm
Net weight	0.12 kg

Environment

Product certifications	CSA UL
Ambient air temperature for operation	-25...70 °C
Ambient air temperature for storage	-40...85 °C
Vibration resistance	25 gn amplitude = +/- 2 mm (f = 10...55 Hz) conforming to IEC 60068-2-6
Shock resistance	50 gn for 11 ms conforming to IEC 60068-2-27

Packing Units

Unit Type of Package 1	PCE
Number of Units in Package 1	1
Package 1 Weight	120 g
Package 1 Height	13 cm
Package 1 width	4.1 cm
Package 1 Length	9.5 cm
Unit Type of Package 2	BAG
Number of Units in Package 2	1
Package 2 Weight	120 g
Package 2 Height	2 cm
Package 2 width	20 cm
Package 2 Length	15 cm

Offer Sustainability

Sustainable offer status	Green Premium product
REACH Regulation	REACH Declaration
EU RoHS Directive	Pro-active compliance (Product out of EU RoHS legal scope) EU RoHS Declaration

Mercury free	Yes
RoHS exemption information	Yes
Environmental Disclosure	Product Environmental Profile
Circularity Profile	End of Life Information
California proposition 65	WARNING: This product can expose you to chemicals including: Diisononyl phthalate (DINP), which is known to the State of California to cause cancer, and Di-isodecyl phthalate (DIDP), which is known to the State of California to cause birth defects or other reproductive harm. For more information go to www.P65Warnings.ca.gov

Contractual warranty

Warranty	18 months
-----------------	-----------

Dimensions

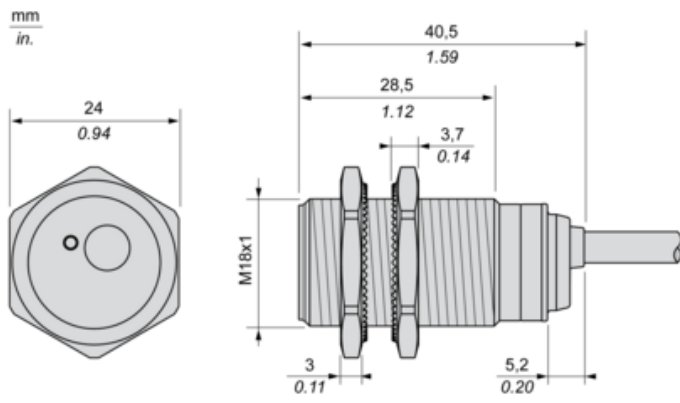

Minimum Mounting Distances

Side by side

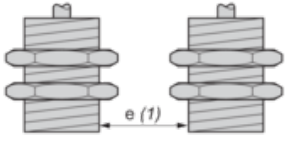

$e (1) \geq 10 \text{ mm}/0.39 \text{ in.}$

Face to face

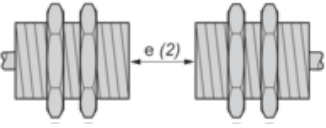

$e (2) \geq 60 \text{ mm}/2.36 \text{ in.}$

Facing a metal object

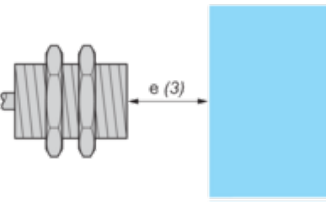

$e (3) \geq 15 \text{ mm}/0.60 \text{ in.}$

Mounting

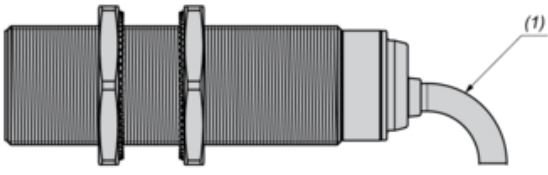

(1) Bending cable: 4 x external cable diameter

Wiring Schemes

NPN

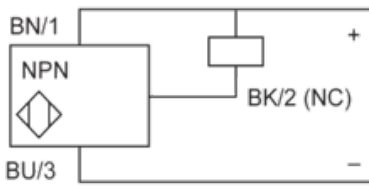

BU : Blue

BN : Brown

BK : Black

Performance Curves

Standard Steel Target : 18x18x1 mm

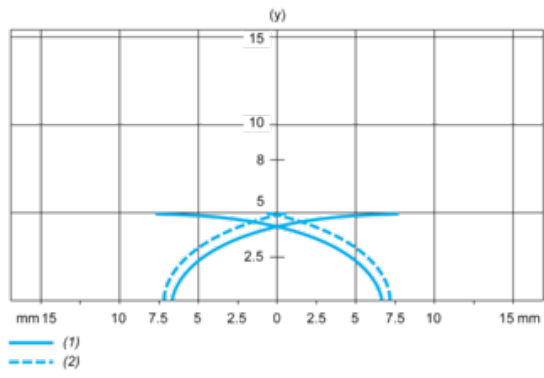

- (1) Pick-up points
- (2) Drop-out points (object approaching from the side)
- (y) Sensing distance in mm