

# Product data sheet

Specifications



## Photoelectric sensors XU, XUK, multi, Sn 0...30 m, 12...24 VDC, cable 2 m

XUK0AKSAL2

### Main

Range of product	Telemecanique Photoelectric sensors XU
Series name	General purpose multimode
Electronic sensor type	Photo-electric sensor
Sensor name	XUK
Sensor design	Compact 50 x 50
Detection system	Multimode
Material	Plastic
Type of output signal	Discrete
Supply circuit type	DC
Wiring technique	3-wire
Discrete output type	PNP or NPN
Discrete output function	1 NO or 1 NC programmable
Electrical connection	Cable
Cable length	2 m
Product specific application	-
Emission	Infrared diffuse Infrared diffuse with background suppression Infrared thru beam Red polarised reflex
[Sn] nominal sensing distance	4 m polarised reflex need reflector XUJC50 30 m thru beam need a transmitter XUK0AKSAL2T 0.28 m diffuse with background suppression 0.8 m diffuse

### Complementary

Enclosure material	PBT
Lens material	PMMA
Maximum sensing distance	35 m thru beam 0.28 m diffuse with background suppression 1.2 m diffuse 5.7 m polarised reflex
Output type	Solid state
Add on output	With alarm output, <= 50 mA with overload and short-circuit protection
Wire insulation material	PvR

<b>Status LED</b>	1 LED (green) for supply 1 LED (red) for instability 1 LED (yellow) for output state
<b>[Us] rated supply voltage</b>	12...24 V DC with reverse polarity protection
<b>Supply voltage limits</b>	10...36 V DC
<b>Switching capacity in mA</b>	<= 100 mA (overload and short-circuit protection)
<b>Switching frequency</b>	<= 250 Hz
<b>Maximum voltage drop</b>	<1.5 V (closed state)
<b>Current consumption</b>	<= 35 mA no-load
<b>Maximum delay first up</b>	200 ms
<b>Maximum delay response</b>	2 ms
<b>Maximum delay recovery</b>	2 ms
<b>Setting-up</b>	Self-teaching
<b>Depth</b>	50 mm
<b>Height</b>	50 mm
<b>Width</b>	18 mm
<b>Net weight</b>	0.175 kg

## Environment

<b>Product certifications</b>	CSA UL CE
<b>Ambient air temperature for operation</b>	-25...55 °C
<b>Ambient air temperature for storage</b>	-40...70 °C
<b>Vibration resistance</b>	7 gn, amplitude = +/- 1.5 mm (f = 10...55 Hz) conforming to IEC 60068-2-6
<b>Shock resistance</b>	30 gn (duration = 11 ms) conforming to IEC 60068-2-27
<b>IP degree of protection</b>	IP65 double insulation conforming to IEC 60529

## Packing Units

<b>Unit Type of Package 1</b>	PCE
<b>Number of Units in Package 1</b>	1
<b>Package 1 Weight</b>	166 g
<b>Package 1 Height</b>	13.2 cm
<b>Package 1 width</b>	9.5 cm
<b>Package 1 Length</b>	4.2 cm
<b>Unit Type of Package 2</b>	S02
<b>Number of Units in Package 2</b>	22
<b>Package 2 Weight</b>	4.018 kg
<b>Package 2 Height</b>	15 cm
<b>Package 2 width</b>	30 cm
<b>Package 2 Length</b>	40 cm

## Offer Sustainability

<b>Sustainable offer status</b>	Green Premium product
<b>REACH Regulation</b>	<a href="#">REACH Declaration</a>

<b>EU RoHS Directive</b>	Pro-active compliance (Product out of EU RoHS legal scope) <a href="#">EU RoHS Declaration</a>
<b>Mercury free</b>	Yes
<b>RoHS exemption information</b>	<a href="#">Yes</a>
<b>Environmental Disclosure</b>	<a href="#">Product Environmental Profile</a>
<b>Circularity Profile</b>	<a href="#">End of Life Information</a>
<b>California proposition 65</b>	WARNING: This product can expose you to chemicals including: Diisononyl phthalate (DINP), which is known to the State of California to cause cancer, and Di-isodecyl phthalate (DIDP), which is known to the State of California to cause birth defects or other reproductive harm. For more information go to <a href="http://www.P65Warnings.ca.gov">www.P65Warnings.ca.gov</a>

## Contractual warranty

<b>Warranty</b>	18 months
-----------------	-----------

## Dimensions

---

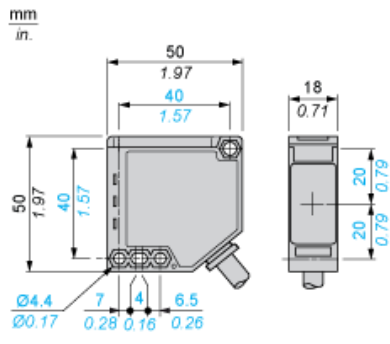

## Wiring Schemes

---

### PNP Output

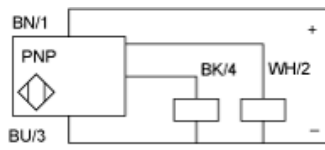

(+) **BN** : Brown  
(-) **BU** : Blue  
(OUT/Output) **BK** : Black  
(Alarm) **WH** : White

### NPN Output

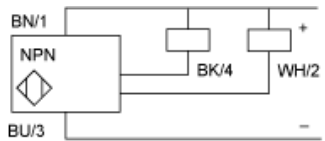

(+) **BN** : Brown  
(-) **BU** : Blue  
(OUT/Output) **BK** : Black  
(Alarm) **WH** : White

**Detection Curves**

**With Thru-beam Accessory (Thru-beam)**

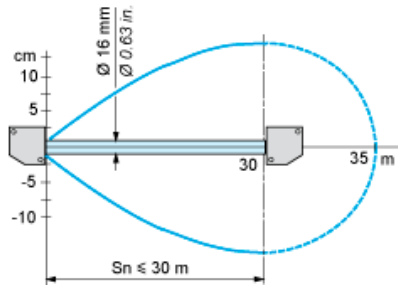

**Without Accessory (Diffuse)**

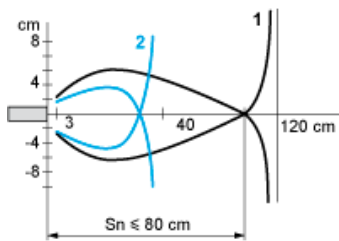

- 1 : White 90%
- 2 : Grey 18%

Object 10 x 10 cm

**Without Accessory (Diffuse with background suppression)**

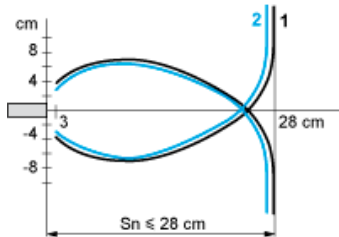

- 1 : White 90%
- 2 : Grey 18%

Object 10 x 10 cm

**With reflector (Polarised reflex)**

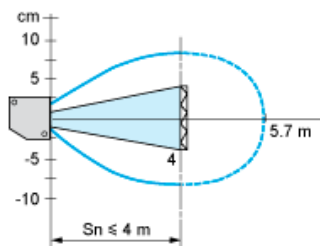

With reflector XU50

**Variation of Usable Sensing Distance Su (Without accessory, with adjustable background suppression)**

Teach Mode at Minimum

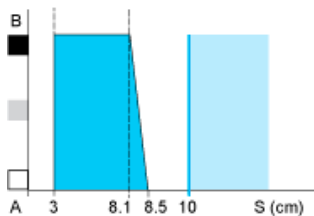

### Teach Mode at Maximum

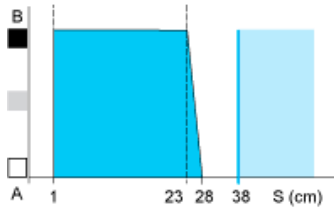

- (1) Black
- (2) Grey
- (3) White
- (4) Sensing range
- (5) Non sensing zone (matt surfaces)

- A-B :** Object reflection coefficient
- (1) Black 6%
  - (2) Grey 18%
  - (3) White 90%
  - (4) Sensing range
  - (5) Non sensing zone (matt surfaces)