

# Product data sheet

Specifications



Inductive proximity sensors XS, inductive sensor XS6 M8, L51mm, stainless, Sn2.5 mm, 12...48 VDC, cable 2 m

XS608B1PBL2

## Main

Range of product	Telemecanique Inductive proximity sensors XS
Series name	General purpose
Sensor type	Inductive proximity sensor
Sensor name	XS6
Sensor design	Cylindrical M8
Size	51 mm
Body type	Fixed
Detector flush mounting acceptance	Flush mountable
Material	Stainless steel
Type of output signal	Discrete
Wiring technique	3-wire
[Sn] nominal sensing distance	2.5 mm
Discrete output function	1 NC
Output circuit type	DC
Discrete output type	PNP
Electrical connection	Cable
Cable length	2 m
[Us] rated supply voltage	12...48 V DC with reverse polarity protection
Switching capacity in mA	<= 200 mA DC with overload and short-circuit protection
IP degree of protection	IP67 conforming to IEC 60529

## Complementary

Thread type	M8 x 1
Detection face	Frontal
Front material	PPS
Enclosure material	Stainless steel 303
Sensing range	> 0...2.5 mm
Operating zone	0...2 mm

Differential travel	1...15% of Sr
Cable composition	3 x 0.11 mm <sup>2</sup>
Wire insulation material	PvR
Status LED	Output state: 1 LED (yellow)
Supply voltage limits	10...58 V DC
Switching frequency	<= 2500 Hz
Maximum voltage drop	<2 V (closed)
Current consumption	<= 10 mA no-load
Maximum delay first up	10 ms
Maximum delay response	0.2 ms
Maximum delay recovery	0.2 ms
Marking	CE
Threaded length	42 mm
Length	51 mm
Net weight	0.035 kg

## Environment

Product certifications	UL CSA
Ambient air temperature for operation	-25...70 °C
Ambient air temperature for storage	-40...85 °C
Vibration resistance	25 gn amplitude = +/- 2 mm (f = 10...55 Hz) conforming to IEC 60068-2-6
Shock resistance	50 gn for 11 ms conforming to IEC 60068-2-27

## Packing Units

Unit Type of Package 1	PCE
Number of Units in Package 1	1
Package 1 Weight	58 g
Package 1 Height	4.3 cm
Package 1 width	9.5 cm
Package 1 Length	13.2 cm
Unit Type of Package 2	S03
Number of Units in Package 2	44
Package 2 Weight	3.174 kg
Package 2 Height	30 cm
Package 2 width	30 cm
Package 2 Length	40 cm

## Offer Sustainability

Sustainable offer status	Green Premium product
REACH Regulation	<a href="#">REACH Declaration</a>
EU RoHS Directive	Pro-active compliance (Product out of EU RoHS legal scope) <a href="#">EU RoHS Declaration</a>

<b>Mercury free</b>	Yes
<b>RoHS exemption information</b>	Yes
<b>Environmental Disclosure</b>	<a href="#">Product Environmental Profile</a>
<b>Circularity Profile</b>	<a href="#">End of Life Information</a>
<b>California proposition 65</b>	WARNING: This product can expose you to chemicals including: Diisononyl phthalate (DINP), which is known to the State of California to cause cancer, and Di-isodecyl phthalate (DIDP), which is known to the State of California to cause birth defects or other reproductive harm. For more information go to <a href="http://www.P65Warnings.ca.gov">www.P65Warnings.ca.gov</a>

## Contractual warranty

<b>Warranty</b>	18 months
-----------------	-----------

Dimensions

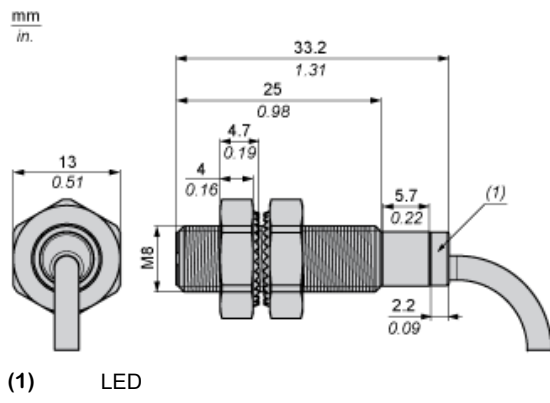

**Minimum Mounting Distances in mm**

---

Side by side

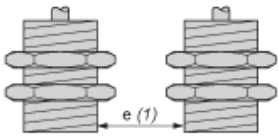

**e (1) ≥ 5 mm/0.20 in.**

Face to face

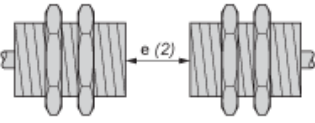

**e (2) ≥ 30 mm/1.18 in.**

Facing a metal object

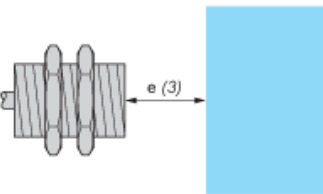

**e (3) ≥ 8 mm/0.31 in.**

**Mounting**

---

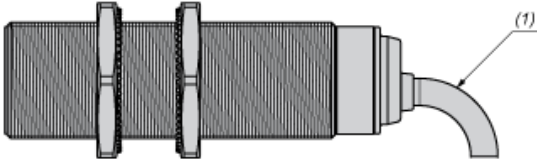

(1) Bending cable: 4 x external cable diameter

**Wiring Schemes**

---

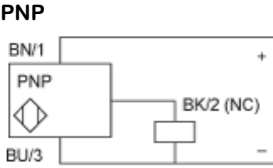

- BU :** Blue
- BN :** Brown
- BK :** Black

Performance Curves

---

Standard Steel Target (mm) : 8x8x1

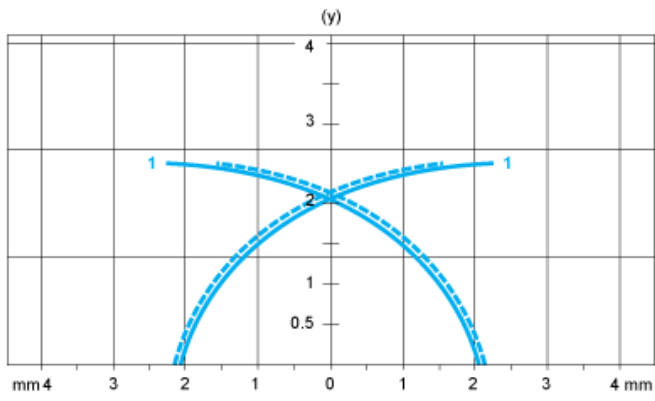

(1) ———  
(2) - - - -

- (1) Pick-up points
- (2) Drop-out points (object approaching from the side)
- (y) Sensing distance in mm